

## PALMA SUSPENSION

### D141241-

base number      Color Temperature      Finish Options      Finish Options

- To build a product code in our configurator select the specify button on the base model # product page
- To build a manual product code on this datasheet choose from the options listed below in blue font and add the suffix to the base model #

#### GENERAL

Series: Vegetal  
 Subseries: Palma  
 Brand: Cangini & Tucci  
 Division: Design  
 Mounting Type: Suspension  
 Mounting Location: Ceiling  
 Subcategory: Pendant

#### PHYSICAL

Shape: Abstract  
 Diameter (mm): 450  
 Diameter (in): 17 <sup>11</sup>/<sub>16</sub>  
 Height (mm): 1000  
 Height (in): 39 <sup>3</sup>/<sub>8</sub>  
 Max. Overall Height (mm): 3000  
 Max. Overall Height (in): 118 <sup>7</sup>/<sub>8</sub>  
 Light Distribution: Omnidirectional  
 Fixture Finish: [AMB](#) / [GRN](#) / [PNK](#) / [RUB](#) / [SKB](#) / [SMK](#) / [TOB](#) / [TRA](#)  
 Holder Finish: SGD / SBK  
 Fixture Material: Glass / Metal  
 Cable Details: 2,000mm Transparent cable

#### ELECTRICAL

Lamp Type: LED (Zhaga Standard)  
 Input Wattage (W): 6  
 Dimming: Non-Dimmable  
 Driver Included: Yes  
 Driver Location: Integrated  
 Driver Class: Class 2  
 Input Voltage (V): 120 - 277  
 Constant Current (mA): 500mA

#### LED

Color Temperature (°K): [2700](#) / [3000](#)  
 Nominal Lumen (lm): 866  
 CRI: >90 CRI  
 Lamp Life (hrs): 50000

#### OPTICAL

#### RATINGS AND CERTIFICATIONS

Certified By: Certified for North American Standards  
 IP rating: IP20

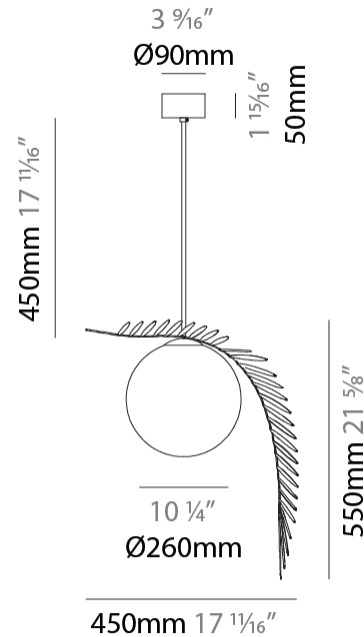

## PALMA SUSPENSION

D141241-

PROJECT

TYPE

SPECIFIER

QUANTITY

DATE

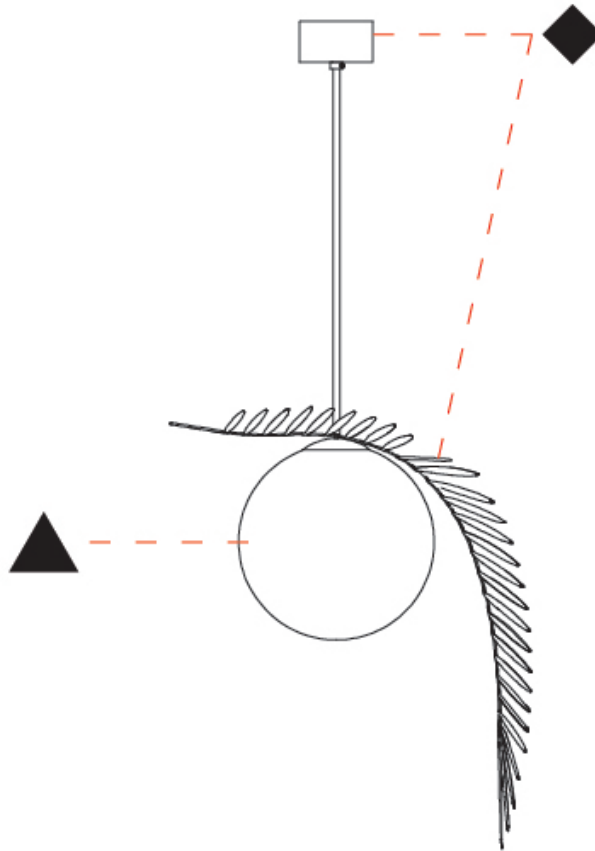

D

## VEGETAL - 7 LIGHT LINEAR SUSPENSION

### D141265-

base number      Color      Finish  
 Temperature      Options

- To build a product code in our configurator select the specify button on the base model # product page
- To build a manual product code on this datasheet choose from the options listed below in blue font and add the suffix to the base model #

#### GENERAL

Series: Vegetal  
 Subseries: Vegetal - 7 Light Linear  
 Brand: Cangini & Tucci  
 Division: Design  
 Mounting Type: Suspension  
 Mounting Location: Ceiling  
 Subcategory: Pendant

#### PHYSICAL

Shape: Abstract  
 Length (mm): 1300  
 Length (in): 51 <sup>3</sup>/<sub>16</sub>  
 Width (mm): 400  
 Width (in): 15 <sup>3</sup>/<sub>4</sub>  
 Height (mm): 220  
 Height (in): 8 <sup>11</sup>/<sub>16</sub>  
 Max. Overall Height (mm): 2220  
 Max. Overall Height (in): 87 <sup>3</sup>/<sub>8</sub>  
 Light Distribution: Omnidirectional  
 Fixture Finish: AMB / GRN / PNK / RUB / SKB / SMK / TOB / TRA  
 Holder Finish: SGD / SBK  
 Accent Finish: CHR / MWH / MBK / BCR  
 Fixture Material: Glass / Metal  
 Cable Details: 2,000mm Transparent cable

#### ELECTRICAL

Lamp Type: LED (Zhaga Standard)  
 Input Wattage (W): 29.4  
 Dimming: Non-Dimmable  
 Driver Included: Yes  
 Driver Location: Integrated  
 Driver Class: Class 2  
 Input Voltage (V): 120 - 277  
 Constant Current (MA): 350mA  
 Upon Request: Phase Dimming (120Vac only) / 0-10V Dimming

#### LED

Color Temperature (°K): 2700 / 3000  
 Nominal Lumen (lm): 3220 / 3500  
 CRI: >90 CRI  
 Lamp Life (hrs): 50000

#### OPTICAL

#### RATINGS AND CERTIFICATIONS

Certified By: Certified for North American Standards  
 IP rating: IP20

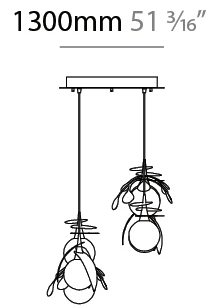
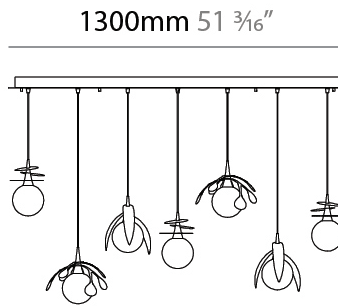

## VEGETAL - 7 LIGHT LINEAR SUSPENSION

D141265-

PROJECT

TYPE

SPECIFIER

QUANTITY

DATE

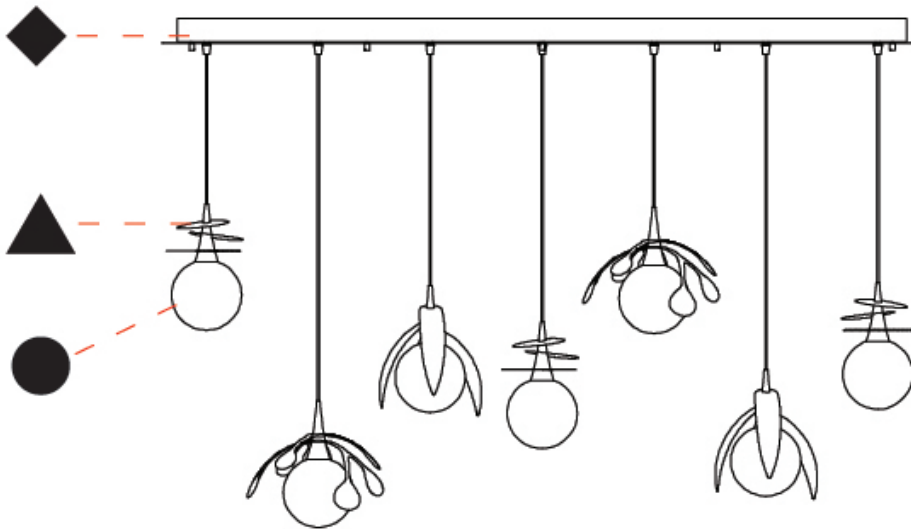

D

## VEGETAL - 3 LIGHT CLUSTER SUSPENSION

### D141266-

base number      Color      Finish  
 Temperature      Options

- To build a product code in our configurator select the specify button on the base model # product page
- To build a manual product code on this datasheet choose from the options listed below in blue font and add the suffix to the base model #

#### GENERAL

Series: Vegetal  
 Subseries: Vegetal - 3 Light Cluster  
 Brand: Cangini & Tucci  
 Division: Design  
 Mounting Type: Suspension  
 Mounting Location: Ceiling  
 Subcategory: Pendant

#### PHYSICAL

Shape: Abstract  
 Diameter (mm): 430  
 Diameter (in): 16 <sup>15</sup>/<sub>16</sub>  
 Height (mm): 220  
 Height (in): 8 <sup>11</sup>/<sub>16</sub>  
 Max. Overall Height (mm): 2220  
 Max. Overall Height (in): 87 <sup>3</sup>/<sub>8</sub>  
 Light Distribution: Omnidirectional  
 Fixture Finish: [AMB](#) / [GRN](#) / [PNK](#) / [RUB](#) / [SKB](#) / [SMK](#) / [TOB](#) / [TRA](#)  
 Holder Finish: [SGD](#) / [SBK](#)  
 Accent Finish: [CHR](#) / [MWH](#) / [MBK](#) / [BCR](#)  
 Fixture Material: Glass / Metal  
 Cable Details: 2,000mm Transparent cable

#### ELECTRICAL

Lamp Type: LED (Zhaga Standard)  
 Input Wattage (W): 12.6  
 Dimming: Non-Dimmable  
 Driver Included: Yes  
 Driver Location: Integrated  
 Driver Class: Class 2  
 Input Voltage (V): 120 - 277  
 Constant Current (MA): 500mA  
 Upon Request: Phase Dimming (120Vac only) / 0-10V Dimming

#### LED

Color Temperature (°K): [2700](#) / [3000](#)  
 Nominal Lumen (lm): 1380 / 1500  
 CRI: >90 CRI  
 Lamp Life (hrs): 50000

#### OPTICAL

#### RATINGS AND CERTIFICATIONS

Certified By: Certified for North American Standards  
 IP rating: IP20

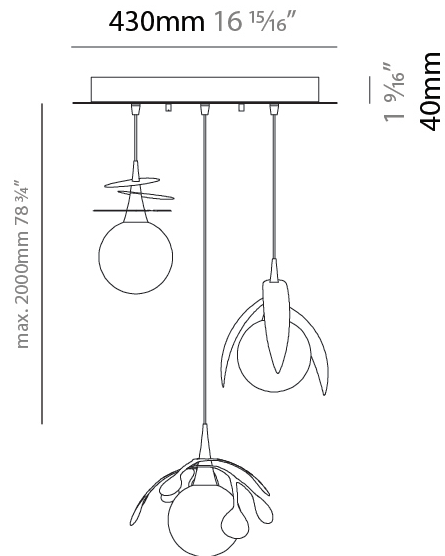

## VEGETAL - 3 LIGHT CLUSTER SUSPENSION

D141266-

PROJECT

TYPE

SPECIFIER

QUANTITY

DATE

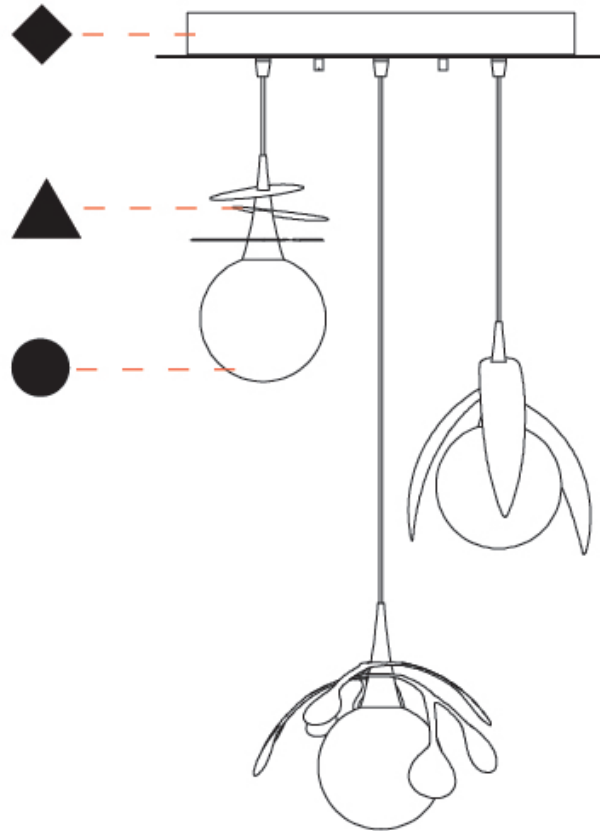

D

PROJECT
TYPE
SPECIFIER
QUANTITY
DATE

## VEGETAL - 3 LIGHT LINEAR SUSPENSION

### D141267-

base number      Color      Finish  
 Temperature      Options

- To build a product code in our configurator select the specify button on the base model # product page
- To build a manual product code on this datasheet choose from the options listed below in blue font and add the suffix to the base model #

#### GENERAL

Series: Vegetal  
 Subseries: Vegetal - 3 Light Linear  
 Brand: Cangini & Tucci  
 Division: Design  
 Mounting Type: Suspension  
 Mounting Location: Ceiling  
 Subcategory: Pendant

#### PHYSICAL

Shape: Abstract  
 Length (mm): 900  
 Length (in): 35 7/16  
 Height (mm): 220  
 Height (in): 8 11/16  
 Max. Overall Height (mm): 2220  
 Max. Overall Height (in): 87 3/8  
 Light Distribution: Omnidirectional  
 Fixture Finish: AMB / GRN / PNK / RUB / SKB / SMK / TOB / TRA  
 Holder Finish: SGD / SBK  
 Accent Finish: CHR / MWH / MBK / BCR  
 Fixture Material: Glass / Metal  
 Cable Details: 2,000mm Transparent cable

#### ELECTRICAL

Lamp Type: LED (Zhaga Standard)  
 Input Wattage (W): 12.6  
 Dimming: Non-Dimmable  
 Driver Included: Yes  
 Driver Location: Integrated  
 Driver Class: Class 2  
 Input Voltage (V): 120 - 277  
 Constant Current (MA): 350mA  
 Upon Request: Phase Dimming (120Vac only) / 0-10V Dimming

#### LED

Color Temperature (°K): 2700 / 3000  
 Nominal Lumen (lm): 1380 / 1500  
 CRI: >90 CRI  
 Lamp Life (hrs): 50000

#### OPTICAL

#### RATINGS AND CERTIFICATIONS

Certified By: Certified for North American Standards  
 IP rating: IP20

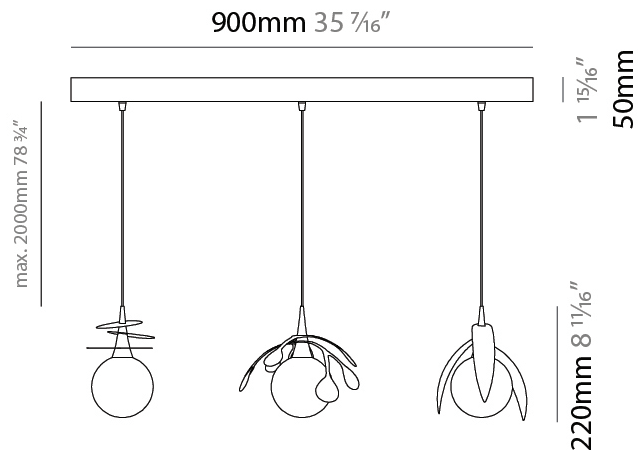

## VEGETAL - 3 LIGHT LINEAR SUSPENSION

D141267-

PROJECT \_\_\_\_\_

TYPE \_\_\_\_\_

SPECIFIER \_\_\_\_\_

QUANTITY \_\_\_\_\_

DATE \_\_\_\_\_

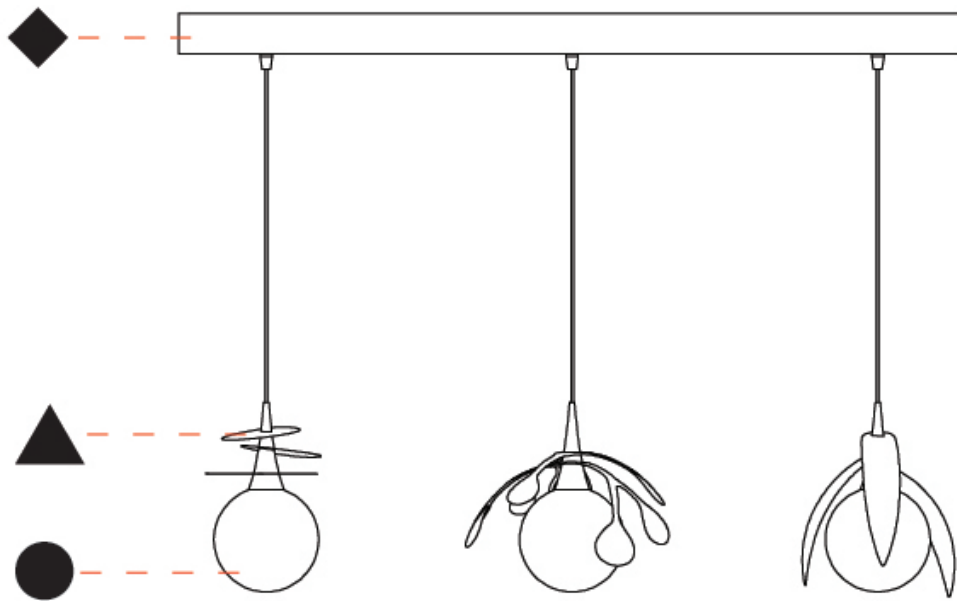

D



## VEGETAL COLOR FINISH CHART

PROJECT \_\_\_\_\_  
TYPE \_\_\_\_\_  
SPECIFIER \_\_\_\_\_  
QUANTITY \_\_\_\_\_  
DATE \_\_\_\_\_

### Fixture Finish

Amber - AMB



Green - GRN



Pink - PNK



Ruby - RUB



Sky Blue - SKB



Smoke - SMK



Tobacco - TOB



Transparent - TRA



### Holder Finish

Satin Gold - SGD



Satin Black Nickel - SBK

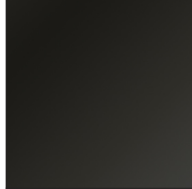

## PALMA,VEGETAL - 7 LIGHT LINEAR,VEGETAL - 3 LIGHT LINEAR,VEGETAL - 3 LIGHT CLUSTER

### SUSPENSION

#### COLOR FINISH CHART

#### Accent Finish

Chrome - CHR

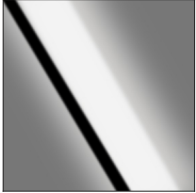

Matte White - MWH

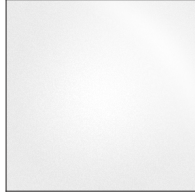

Matte Black - MBK



Brushed Chrome - BCR

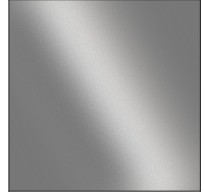

**Digital:** Not all screens are calibrated the same, and therefore, colors will appear differently between screens.

**Physical:** When texture is involved, there will be variations in color, character and tone within a product series and between product families.



### LEGEND

	floor-mounted		pivotal		special LED (upon request) RGB, RGBW, tunable, gold+, meat+, art+, fashion+
	wall and ceiling: recessed and surface mounted		rotating		warm dim / natural dimming LED
	ceiling-mounted and wall-mounted		illuminate tilted		rechargeable battery powered
	wall-mounted		color of suspension cable		fixture with natural vivid LED (upon request)
	omni-directional light distribution		length of suspension cable		color rendering index
	direct light distribution		reflector degree selection		color temperature
	direct/indirect light distribution		super spot		lumen (luminous flux)
	indirect light distribution		lens		efficacy (lumens per watt)
	asymmetric light distribution		lens pack		Unified Glare Rating (UGR) range from 5-40
	aura light distribution		shine ring		marine grade (AISI 316 stainless steel)
	round wall or ceiling cut-out		integrated shine ring with diffuser		walk on
	square wall or ceiling cut-out		free individual colors 01-29		drive on
	the supplied jig specifies the cutout dimensions		individual colors: 00 (free of charge), 01-25 (extra charge)		Dark Sky Compliance
	minimum distance (meters) lamp - object		luminaire part to be colored (F1)		Americans with Disabilities Act (less than 4" off the wall located between 27"-84" from floor)
	recessed depth		luminaire part to be colored (F2)		lamp protected against explosion
	ceiling thickness in mm		luminaire part to be colored (F3)		blown glass using traditional methods by master glass blower
	ceiling thickness selection		luminaire part to be colored (F4)		acoustic material
	dimmable DP (phase), DV (0-10V), DD (dali), DS (step-dim)		luminaire part to be colored (F5)		protection class I, protection insulation
	included or excluded LED driver/transformer/control gear		color of 3-circuit adaptor		protection class II, protection insulation
	separately switchable		indirect diffuser		ETL Certified to UL and CSA Standards
	sensor		direct diffuser		UL Certified to UL and CSA Standards
	remote control		ball-proof (upon request)		CSA Certified to UL and CSA Standards
	available upon request		accessory		Certified for North American Standards

### IP RATING

	protected against ingress of solid bodies greater than 12.5mm (finger)
	protected against ingress of solid bodies greater than 2.5mm protected against sprays of water up to 60 degrees from the vertical (rain)
	protected against ingress of solid bodies greater than 1mm (wire) no protection against the ingress of moisture
	protected against ingress of solid bodies greater than 1mm (wire) protected against sprays of water up to 60 degrees from the vertical (rain)
	protected against ingress of solid bodies greater than 1mm (wire) protected against water splashed from all directions
	protected against limited ingress of dust (wet rooms/covered outdoor areas) protected against water splashed from all directions
	protected against ingress of dust protected against jets of water
	protected against ingress of dust protected against powerful jets of water or heavy seas
	protected against ingress of dust protected against immersion of water between 15cm - 1m for 30 minutes
	protected against ingress of dust protected against immersion of water under pressure for long periods

### IK RATING

	protected against 0.14 joules impact (equivalent to 0.25kg mass dropped from 56mm above the surface)
	protected against 0.2 joules impact (equivalent to 0.25kg mass dropped from 80mm above the surface)
	protected against 0.35 joules impact (equivalent to 0.25kg mass dropped from 140mm above the surface)
	protected against 0.5 joules impact (equivalent to 0.25kg mass dropped from 200mm above the surface)
	protected against 0.7 joules impact (equivalent to 0.25kg mass dropped from 280mm above the surface)
	protected against 1 joules impact (equivalent to 0.25kg mass dropped from 400mm above the surface)
	protected against 2 joules impact (equivalent to 0.5kg mass dropped from 400mm above the surface)
	protected against 5 joules impact (equivalent to 1.7kg mass dropped from 300mm above the surface)
	protected against 10 joules impact (equivalent to 5.0kg mass dropped from 200mm above the surface)
	protected against 20 joules impact (equivalent to 5.0kg mass dropped from 400mm above the surface)